

Space saving stack and nest containers

Nesting storage and transport containers provide economical solutions and multiple uses for returnable packaging and order picking applications.

The three basic options for volume reduction in containers with rigid outer walls are:

- ▶ Conical containers with bail arms – can be stacked inside each other or on top of each other by turning the bail arms by 180° (see KMB with bail arms).
- ▶ Stack and nest containers – can be stacked full with or without a lid and stacked inside each other by rotating 180°.
- ▶ Conical containers which can only be stacked with a lid or nested empty inside each other without a lid.

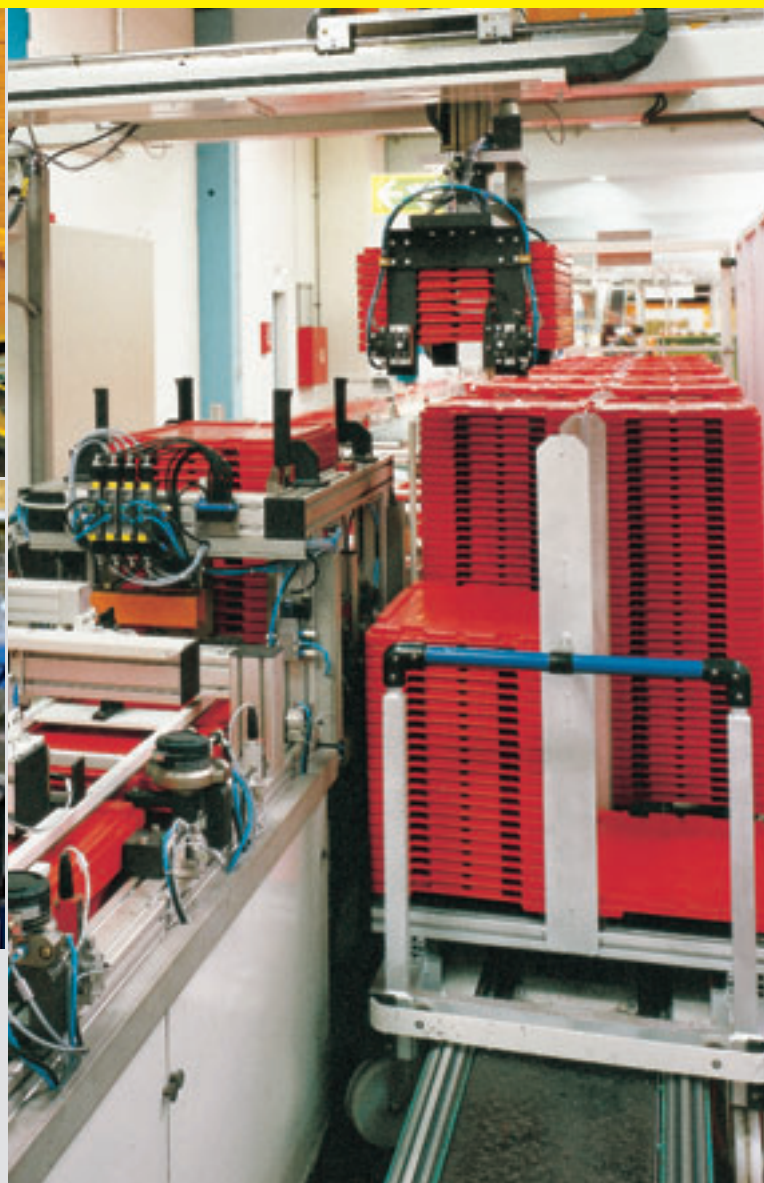

BLUE



Additional colours on request



- ▶ **Polypropylene**
resistant to most acids and alkalis, withstands temperatures between -20° and +90° Celsius, the base material is suitable for use with foodstuffs
- ▶ **Space gain**
75% space gain when empty
- ▶ **Automatic unstacking possible**
from sides and front
- ▶ **Ergonomic**
thanks to comfortably designed hand grips
- ▶ **Easy cleaning**
thanks to smooth surfaces and optimally placed water drainage holes
- ▶ **Ribbed base optional**
max. load up to 50 kg
- ▶ **Quiet running**
on conveyors
- ▶ **Easy gripping**
on conveyors thanks to rough base
- ▶ **Barcode areas**
protected against damage and dust due to special arrangement



Vibration welding base VS01

KMB – conical multi-use containers



Smooth sub-floor



Reinforced base VB01

KMB – conical multi-use containers without bail arm and lid

Item	Interior dim. when stacked L x W x useable height (mm)	External dim. with anti-lifting device L x W (mm)	External dim. at base L x W (mm)	Capacity (litre)	Base	Order no.
KS 3153	242 x 150	—	245 x 153	6,3		16474
KMB 422	315 x 235 x 220	407 x 299	320 x 240	18,0		75514
KMB 617	500 x 330 x 169	607 x 399	505 x 335	29,0		75364
KMB 617 VB01	500 x 330 x 169	607 x 399	505 x 335	29,0		75394
KMB 622	500 x 330 x 219	607 x 399	505 x 335	38,0		75544
KMB 622 VB01	500 x 330 x 219	607 x 399	505 x 335	38,0		75574
KMB 627	500 x 330 x 269	607 x 399	505 x 335	47,0		75424
KMB 627 VB01	500 x 330 x 269	607 x 399	505 x 335	47,0		75454
KMB 627 VS01	500 x 330 x 250	607 x 399	505 x 335	44,0		74794
KMB 632	500 x 330 x 319	607 x 399	505 x 335	58,0		75604
KMB 632 VB01	500 x 330 x 319	607 x 399	505 x 335	58,0		75634
KMB 642	500 x 330 x 419	607 x 399	505 x 335	74,0		75924
KMB 642 VB01	500 x 330 x 419	607 x 399	505 x 335	74,0		75954
KMB 832	700 x 330 x 319	807 x 399	705 x 335	76,0		75664

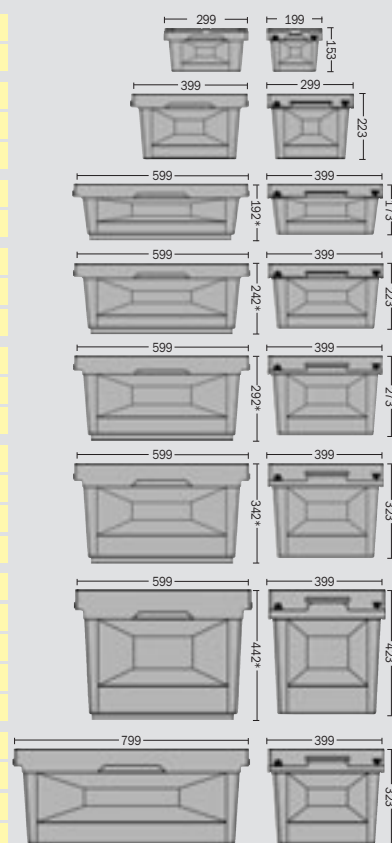

Smooth Reinforced base Vibration welding base (VS01 base)

* Height for VB01 model



Anti-lifting device



Bail arm opening



Ergonomically designed comfortable hand grips

BLUE

Additional colours on request

KMB with bail arms



Stacking principal with bail arms

- In addition to:**
the KMB advantages (comp. p. A67 model without bail arm and lid)
- ▶ **Easy to handle bail arms**
 - ▶ **High handling security**
simple handling thanks to locking function
 - ▶ **Exact fit**
exact fit of the bail arms – turned out or turned in
 - ▶ **Strong bail arms**
material reinforced with glass fibre
 - ▶ **Each bail arm is replaceable**
 - ▶ **No limitation of the effective volume**

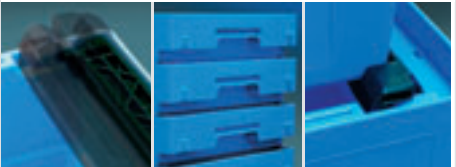

Bail arms for stacking when full or empty with a rotation of 180° and locking device

KMB – conical multi-use containers with bail arms



Item	Internal dim. when stacked L x W x useable H (mm)	External dim. with anti-lifting device	Exterior dim. at base L x W (mm)	Incl. the following accessories	Capacity ¹⁾ (litre)	Base	Order no.
KMB-B 422	315 x 235 x 208	407 x 299	320 x 240	2 brackets KMB-B300		Smooth	75524
KMB-B 617	500 x 330 x 157	607 x 399	505 x 335	2 brackets KMB-B400		Smooth	75374
KMB-B 617 VB01	500 x 330 x 157	607 x 399	505 x 335	2 brackets KMB-B400		VB	75404
KMB-B 622	500 x 330 x 207	607 x 399	505 x 335	2 brackets KMB-B400		Smooth	75554
KMB-B 622 VB01	500 x 330 x 207	607 x 399	505 x 335	2 brackets KMB-B400		VB	75584
KMB-B 627	500 x 330 x 257	607 x 399	505 x 335	2 brackets KMB-B400		Smooth	75434
KMB-B 627 VB01	500 x 330 x 257	607 x 399	505 x 335	2 brackets KMB-B400		VB	75464
KMB-B 627 VS01	500 x 330 x 238	607 x 399	505 x 335	2 brackets KMB-B400		VS	74984
KMB-B 632	500 x 330 x 307	607 x 399	505 x 335	2 brackets KMB-B400		Smooth	75614
KMB-B 632 VB01	500 x 330 x 307	607 x 399	505 x 335	2 brackets KMB-B400		VB	75644
KMB-B 642	500 x 330 x 407	607 x 399	505 x 335	2 brackets KMB-B400		Smooth	75934
KMB-B 642 VB01	500 x 330 x 407	607 x 399	505 x 335	2 brackets KMB-B400		VB	75964
KMB-B 832	700 x 330 x 307	807 x 399	705 x 335	2 brackets KMB-B400		Smooth	75674

* Height for VB01 model

¹⁾ as table on page A67

Smooth **VB** Reinforced base **VS** Vibration welding base (VS01 base)



Bail arms turned in for nesting



Bail arms turned out for stacking



Bail arms locked

BLUE



Additional colours on request



In addition to:

the KMB advantages (comp. p. A67 model without bail arm and lid)

- ▶ **Stackable when closed**
available in different base sizes and heights
- ▶ **Optimal protection of the goods against dust**
- ▶ **High handling security**
thanks to seal
- ▶ **Additional security**
because of banding grooves
- ▶ **High volume reduction**
when empty, due to close fitting lids
- ▶ **Each lid is individually exchangeable**
with hinge system



Stacking with closed lid Sealing



Stacking principal with hinged lid



KMB with hinged lid

KMB – conical multi-use containers with hinged flap-lid

Item	Internal dim. when stacked L x W x useable H (mm)	External dim. with anti-lifting device (mm)	Exterior dim. at base L x W (mm)	Incl. the following accessories	Capacity ⁴⁾ (litre)	Base	Order no.
KMB-DH 422	315 x 235 x 213	409 x 299	320 x 240	1 x KMB-DH43, 4 x KMB-DS**			75534
KMB-DH 617	500 x 330 x 162	609 x 399	505 x 335	1 x KMB-DH64, 6 x KMB-DS**			75384
KMB-DH 617 VB01	500 x 330 x 162	609 x 399	505 x 335	1 x KMB-DH64, 6 x KMB-DS**			75414
KMB-DH 622	500 x 330 x 212	609 x 399	505 x 335	1 x KMB-DH64, 6 x KMB-DS**			75564
KMB-DH 622 VB01	500 x 330 x 212	609 x 399	505 x 335	1 x KMB-DH64, 6 x KMB-DS**			75594
KMB-DH 627	500 x 330 x 262	609 x 399	505 x 335	1 x KMB-DH64, 6 x KMB-DS**			75444
KMB-DH 627 VB01	500 x 330 x 262	609 x 399	505 x 335	1 x KMB-DH64, 6 x KMB-DS**			75474
KMB-DH 627 VS01	500 x 330 x 243	609 x 399	505 x 335	1 x KMB-DH64, 6 x KMB-DS**			74994
KMB-DH 632	500 x 330 x 312	609 x 399	505 x 335	1 x KMB-DH64, 6 x KMB-DS**			75624
KMB-DH 632 VB01	500 x 330 x 312	609 x 399	505 x 335	1 x KMB-DH64, 6 x KMB-DS**			75654
KMB-DH 642	500 x 330 x 412	609 x 399	505 x 335	1 x KMB-DH64, 6 x KMB-DS**			75944
KMB-DH 642 VB01	500 x 330 x 412	609 x 399	505 x 335	1 x KMB-DH64, 6 x KMB-DS**			75974
KMB-DH 832	700 x 330 x 312	809 x 399	705 x 335	1 x KMB-DH84, 10 x KMB-DS**			75684

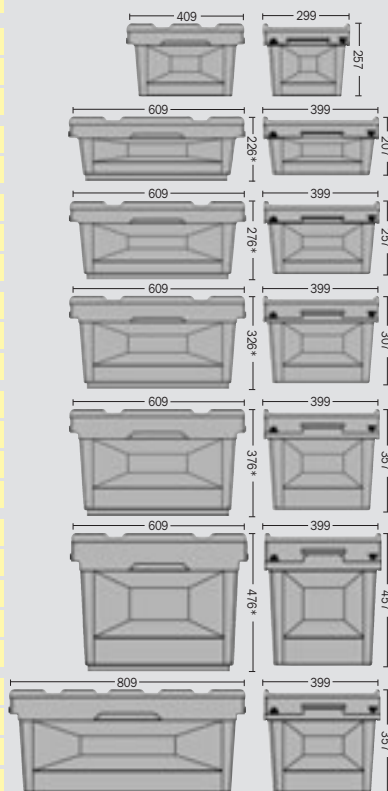

⁴⁾ as table on page A67

* Height for VB01 model

** Flap-lid KMB-DH and hinged parts KMB-DS

Smooth Reinforced base

Vibration welding base (VS01 base)



Sealing option



Lids tight fitting when turned out



Banding grooves



BLUE

Additional colours
on request

Accessories for KMB

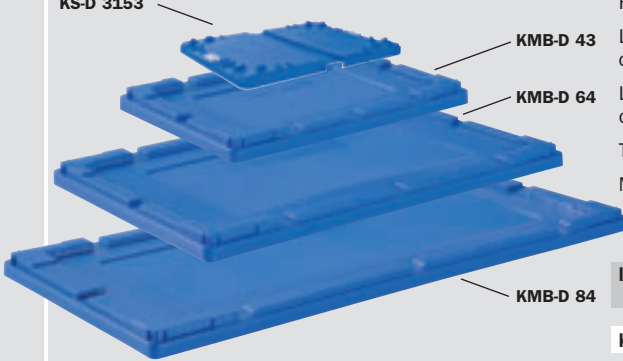

Slip lid

For KMB and KMB-B series.

Lid collar all the way around the container and banding option. The containers can still be stacked even with the lid.

Loose lids can be stacked inside one another to save space. Available with or without optional seal opening.

The roughened middle area simplifies label handling.

Material: Polypropylene.

Item	For base dim. L x W (mm)	Finish	Order no.
KS-D 3153	300 x 200	with film hinge and snap-hook, foldable	16484
KMB-D 43	400 x 300		75344
KMB-D 64	600 x 400		75354
KMB-D 84	800 x 400		75334







RED GREEN YELLOW BLUE



Stack and nest containers

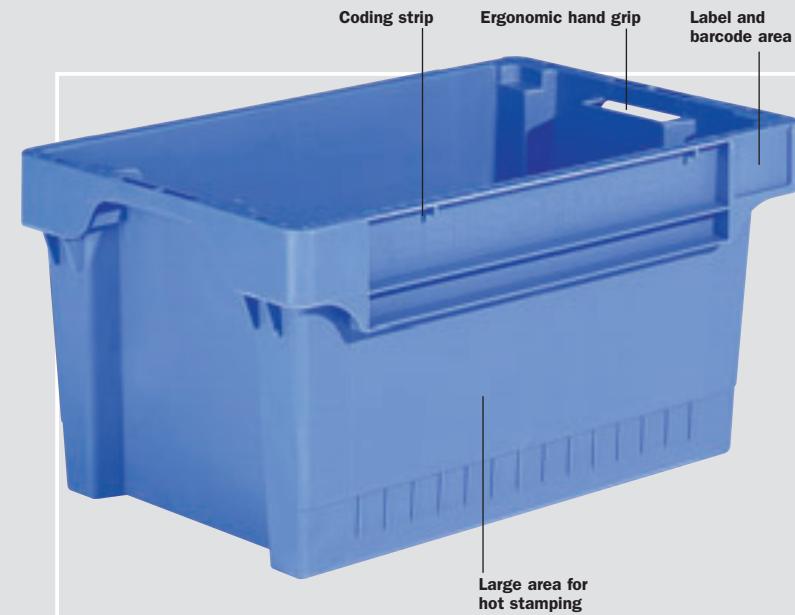

- ▶ A “stack and nest” container means that: when empty, the containers may be nested inside one another, but when full, they can be turned through 180° and stacked on top of each other even without lids
- ▶ **Enormous storage space saving** without surplus stock and transport of empty containers

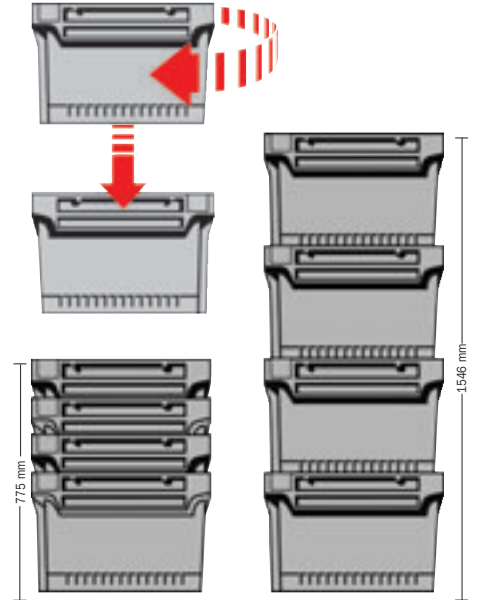

The different models can be stacked together

Euro-Fix-Boxes EFB



Euro-Fix-Boxes

Made from polypropylene with Euro dimensions (base dimension L 600 x W 400 mm). The three heights can be stacked together.

Excellent qualities of the Euro-Fix-Box make it ideal for use on conveyors and as an environmentally friendly order-picking and transport container.

Item	Useable internal dim. top/bottom L x W x H (mm) when stacked	Capacity (litre)	Base	Walls	Order no.
Height 200 mm					
EFB 642	506/500/473 x 363/325 x 175	36,0			25801 25802 25803 25804
EFB-L 642	506/500/473 x 363/325 x 175	36,0			25911 25912 25913 25914
EFB-B 642	506/500/473 x 363/325 x 175	36,0			25941 25942 25943 25944
EFB-LB 642	506/500/473 x 363/325 x 175	36,0			25971 25972 25973 25974
Height 300 mm					
EFB 643	506/500/473 x 363/325 x 275	54,0			25831 25832 25833 25834
EFB-L 643	506/500/473 x 363/325 x 275	54,0			25921 25922 25923 25924
EFB-B 643	506/500/473 x 363/325 x 275	54,0			25951 25952 25953 25954
EFB-LB 643	506/500/473 x 363/325 x 275	54,0			25981 25982 25983 25984
Height 400 mm					
EFB 644	506/500/473 x 363/325 x 375	72,0			25861 25862 25863 25864
EFB-L 644	506/500/473 x 363/325 x 375	72,0			25931 25932 25933 25934
EFB-B 644	506/500/473 x 363/325 x 375	72,0			25961 25962 25963 25964
EFB-LB 644	506/500/473 x 363/325 x 375	72,0			25991 25992 25993 25994

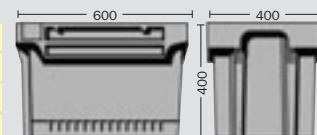
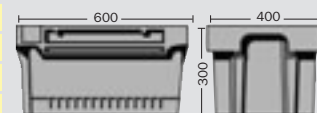
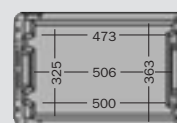

Closed Perforated

Lid

With external open hand grip (no volume loss). Compatible with all types. Space saving stackable. Stacking lugs ensure stability of stacked boxes. Banding grooves for secure banding of stapled boxes.

Item	Order no.
EFB-D	25891 25892 25893 25894



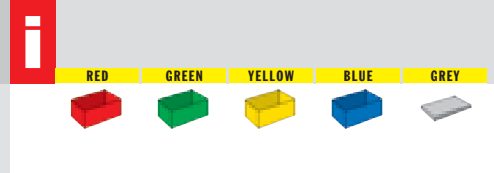

Fix-Boxes FB



Fix-Box FB 600

Polyethylene. Capable of carrying heavy loads, sturdy, with hand grips in the strong rims. Transport container for rail and road. Can be stacked when closed.

External dimensions: L 600 x W 400 x H 250 mm

Item	Useable internal dim. L x W x H (mm) top/bottom	Capacity (litre)	Order no.			
FB 600	550/500 x 360/325 x 247	40	8351	8352	8353	8354

Lid for Fix-Box FB 600

Item	Finish	Order no.			
FB-D 600	with stacking corners	8361	8362	8363	8364



Fix-Box 603

Polypropylene, with open hand grips at the front ends, without lid.

External dimensions: L 597 x W 397 x H 300 mm

Item	Useable internal dim. L x W x H (mm) top/bottom	Capacity (litre)	Order no.			
FB 603	565/530 x 364/334 x 297	57	12481	12482	12483	12484



Fix-Box 604

Polypropylene. This model is also compatible with Euro-pallet dimensions of 1200 x 800 mm. Open hand grips on both front sides for easy handling. Can be stacked even with lid.

External dimensions: L 600 x W 400 x H 350 mm

Item	Useable internal dim. L x W x H (mm) top/bottom	Capacity (litre)	Order no.			
FB 604	530/475 x 350/306 x 347	62	8381	8382	8383	8384

Lid for Fix-Box FB 604

Item	Finish	Order no.			
FB-D 604	with stacking corners	15051	15052	15053	15054







Fix-Boxes FB

Fix-Box FB 530

Polypropylene. With shell hand grips. Suitable for Euro-pallets.
External dimensions: L 540 x W 320 x H 170 mm







Item	Useable internal dim. L x W x H (mm) top/bottom	Capacity (litre)	Order no.
			   
FB 530	420/425 x 275/255 x 167	17	12471 12472 12473 12474

Fix-Box FB 601

Polypropylene. With shell hand grips at the front ends integrated into the stacking rim. Suitable for stacking rims.
External dimensions, top: L 585 x W 375 x H 200 mm



Item	Useable internal dim. L x W x H (mm) top/bottom	Capacity (litre)	Order no.
			   
FB 601	490/420 x 330/300 x 197	30	8441 8442 8443 8444

Lid for Fix-Box FB 601



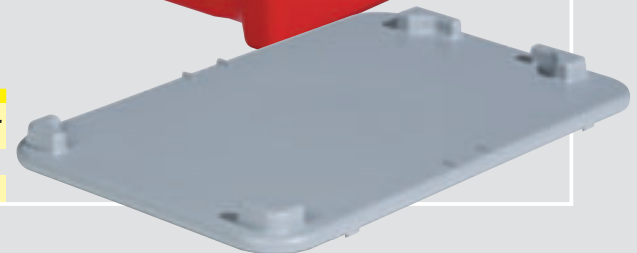

Item	Finish	Order no.
		
FB-D 601	with stacking corners	20905



Fix-Box FB 650

Polyethylene. Specially designed for the transport of large, relatively light items.
External dimensions, top: L 650 x W 500 x H 150 mm



Item	Useable internal dim. L x W x H (mm) top/bottom	Capacity (litre)	Order no.
			   
FB 650	600/540 x 450/430 x 147	40	12461 12462 12463 12464

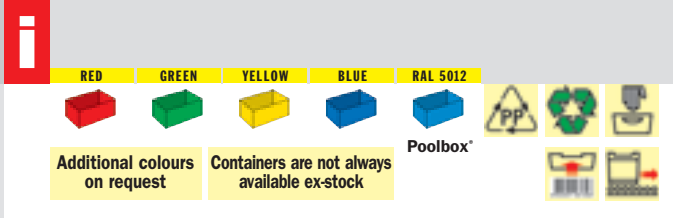

Conical transport and order-picking container, Poolbox®



KS 18

Polypropylene, with label area 110 x 60 mm on both edges for coding and labeling, smooth internal walls.

External dimensions top/bottom: L 775/655 x W 535/415 x H 315 mm

Item	Useable internal dim. L x W x H (mm) top/bottom	Capacity (litre)	Order no.
KS 18	720/640 x 480/400 x 310	90,0	15171 15172 15173 15174

Lid for KS 18

Item	Finish	Order no.
KS-D 18		15291 15292 15293 15294
KS-D 18 V2	with groove for KS 51/KS 52	15271 15272 15273 15274



KS 51/KS 52

Polypropylene, for use on roller and belt conveyors, for order-picking, transport and shipping. Option to store coded labels on the edge and on the side walls close to the base. The containers can be stacked with lid and banding and can be banded together when stacked. Also with code inserts and strips. Standard version without coding facility. Colours on request.

KS 51 External dimensions: L 500/435 x W 360/275 x H 123 mm

KS 52 External dimensions: L 500/440 x W 360/275 x H 253 mm

Item	Useable internal dim. L x W x H (mm) top/bottom	Capacity (litre)	Order no.
KS 51	460/429 x 320/269 x 120	15,0	21101 21102 21103 21104
KS 52	465/435 x 320/269 x 250	32,0	21121 21122 21123 21124

Lid for KS 51/KS 52

Item	Finish	Order no.
KS-D 51	no hook	15921 15922 15923 15924
KS-DH 51	with hook	21111 21112 21113 21114
KS-DH 52	with hook	21131 21132 21133 21134



Poolbox®

Polypropylene. Conical transport container, with lockable lid, can be used on conveyors in any form. Dust and spray-water sealed, secure handling due to ergonomically designed hand grips, sealable. Lids have an area which enables labels and paperwork holders to be easily stuck down or removed. Dimensions are compatible with Euro pallet dimensions.

Colour: Blue (RAL 5012), different colours on request.

External dimensions: L 600 x W 400 x H 320 mm

Item	Internal base dim. L x W (mm)	Capacity (litre)	Order no.
PB 6320	457 x 318	approx. 49,0	844

Lid for Poolbox®

Lid with external open hand grip (no volume loss).

Colour: Blue (RAL 5012), different colours on request.

Item	Finish	Order no.
PB-D 64	can be sealed	874

Identification options for boxes and containers

All of the containers may be stamped with numbers, codes or your company name and logo – an individual service from SSI SCHAEFER.

Hot stamping

With standard letters (10 or 24 mm high) or your company logo. In addition, the containers can have up to 6 digit numbers in 11, 19 or 30 mm height.

Please request further information on minimum quantities and prices for containers for hot stamping.



Die-forming

With stamping tools, the company name or logo can be incorporated within the container as it is being produced. Only available in container colour.

Please request further information on minimum quantities and prices for containers for mould stamping.



Silk screen printing

Silk screen printing is another way in which containers can be identified with their company name or logo.

Please request further information on minimum quantities and prices for containers with screen stamping.



Individual and special solutions made from plastic

Special applications demand the use of special plastic containers. SSI SCHAEFER has developed and customised a wide range of special containers according to customer requirements.

If you need a special container to suit your needs, our development team would be pleased to help you find the perfect solution.

i **Further information**
on request

Stack and nest containers – KS 1, KS 8, KS 10, KS 16 and KS 17 series



Conical transport and order picking containers – KS 5, KS 9 and KS 43 series



Conical transport and order picking containers – KS 6100 and KS 6200 series



Stackable and conical transport containers, special containers and folding containers

Conical order picking and stepped containers –
KS 4217, KS 6217 and Konfix KF series



Conical containers with bail arm –
Konfix KFB serie



Conical containers with bail arm –
4245, KS 5245 and KS 6245 series



Special containers –
KS, 14/6 R and FK series



Special containers –
KS 12, KS 14, KS 19 series



Special containers –
SK 180 and SK 200 series



Special containers –
FK box serie

